



**BAR MART**

**PROVIDING BAR & RESTAURANT  
SUPPLIES SINCE 1953**

**2018**

**BAR/CLUB/RESTAURANT  
CATALOG**

**Dallas/Fort Worth  
2510 Gravel Drive  
Fort Worth, TX 76118  
817-595-0667  
dfw@barmart.net**

**Austin/San Antonio  
6816 Lee Manor Cove #102  
Manor, TX 78653  
512-272-4757  
atx@barmart.net**

**BARMART.NET / 800-878-2425**





2510625



2510020



2510480



2510525



2510350



2511053



2510975



2510990



2511026



2510701



2110110



2512020



2513213



2136011



2136002



2137100



2512601



2136050



**2132855**  
**Fast-Pour**



**2132860**  
**Half-Gallon**



**2133210**  
**Screened**



**2135135**  
**Patron**



**2135204**  
**Measured**  
**1oz**



**2135207**  
**Measured**  
**1 1/4 oz**



**2135208**  
**Measured**  
**1 1/2 oz**



**2133412**  
**Economy**



**2133406**  
**Economy**



**2133410**  
**Economy**



**2133404**  
**Economy**



**2133402**  
**Economy**



**2133408**  
**Economy**



**2139000**  
**Small**  
**Nitecaps**



**2139002**  
**Large**  
**Nitecaps**



**2139020**  
**Draught Tap**  
**Covers**



**2139025**  
**Beer Tap Brush**  
**6cnt**



**2139022**  
**Beer Tap Brush**  
**5cnt**



**2139010**  
**Large Dust**  
**Caps**





2110222



2110223



2110224



2141012



2141020



2141032



2141034



2141054



2143432



2515115



2515110



2110306



2515125



2515126



2110302



2110308



2515001



2515002



2110400



2110401



2110390  
Pint  
Glass

16oz



2110300



2515025

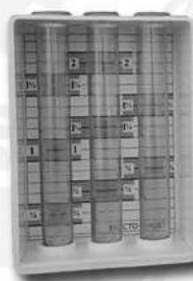

2135503



2515142



22" 2172122

32" 2172132

42" 2172142



22" 2172222

32" 2172232

42" 2172242



4oz 2127130



5oz 2127005



12oz 2127012



24oz 2127024



38oz 2127038



58oz 2127058



Plastic

64oz 2127266



85oz 2127085



6212611

BRUTE

BRUTE

ICE ONLY

10 GAL ICE ONLY  
6212612



5 GAL  
9215310



MED Holder  
2127280



LRG Holder  
2127290

**6 BAR TOOLS**





2111200



3" x 23 1/2"  
Spill Mat  
2111242



12" x 18"  
Spill Mat  
2111252

2111210



2111130

AEROLINER 24" X 40'

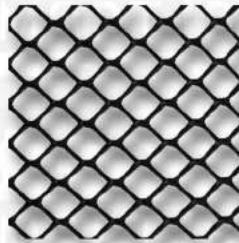

2180013 BLACK



2180000 CLEAR



12" x 12"  
Interlocking Mat  
2111282



32oz

24oz

16oz

12oz

2408314

2408311

2408308

2408307

Windsor  
Pattern



2400014



2400017



2400039

Dots  
Pattern



2400040



2400043



2405036



9200101R



9200101G



9200101Y



9200101O



9200101



32 oz

9200102



9200100





14" Cork-Lined  
2112114

16" Cork-Lined  
2112116



14" Non-Skid  
2112214

16" Non-Skid  
2112216



2408112



2406117



2112000



1/2  
Litre

1 Litre

9202003

9997001

9997000



2126000

8-Quart



2516002



2300100



2408202



9905045



6cnt  
9701310



3 3/4" 36cnt  
9905143



4" 36cnt  
9905154



5" 36cnt  
9905164

Plastic  
12cnt Boxes



2310512

2310504







STAINLESS STEEL  
6-COMPARTMENT

2170406



PLASTIC  
6-COMPARTMENT

2170506



16oz

9200201



32oz

9200202



Fruit Knife

2110310



12"x18"  
2110316

2110368



2110502



6"x10"  
2110314



2110388



2406320



2406322



2406321



1916200



1915165



1916772



# 10 oz 24-Pack Cases



1715110  
CLUB SODA



1715210  
TONIC



1715211  
DIET TONIC



1715310  
GINGER ALE



1715510  
GINGER BEER



1715610  
BITTER LEMON

# 1 LTR 12-Pack Cases



1715101  
CLUB SODA



1715201  
TONIC



1715220  
DIET TONIC



1715301  
GINGER ALE



1715321  
DIET GINGER ALE



1715501  
GINGER BEER





60 oz / 8 cnt  
1311160



60 oz / 8 cnt  
1312560



60 oz / 8 cnt  
1311336



46 oz / 12 cnt  
1310347



32 oz / 12 cnt  
1311132



32 oz / 12 cnt  
1312532



32 oz / 12 cnt  
1311332



32 oz / 12 cnt  
1312580



46 oz / 12 cnt  
1313446



5.5 oz / 48 cnt  
1312508



5.5 oz / 48 cnt  
1312506



5.5 oz / 48 cnt  
1312507



6 oz / 48 cnt  
1310312



5.5 oz / 48 cnt  
1313406



5.5 oz / 24 cnt  
1311208



16.9 oz / 40 cnt  
1711024



32 oz / 8 cnt  
1313432



**Lemon S&S Concentrate**  
1111100



**Grenadine RTU**  
1111218



**Triple Sec N/A RTU**  
1111216



**Emerald Lime S&S**  
1111102



**Blue Curacao**  
1111217



**Bar Syrup**  
1111214



**Pina Colada**  
1111130



**Strawberry Daiquiri**  
1111220



**Rose's Lime Juice**  
1127202



**Rose's Grenadine Syrup**  
1127218



**Bar Blend Lime Juice**  
1127302



**Olive it Dirty Martini Mix**  
1909025



**Van Holten's Pickle Brine**  
1124032



**Old Comiskey Bloody Mary**  
1123161



**Major Peters' Bloody Mary**  
1123160



**Clamato Bloody Mary**  
1122162



**Van Holten's Freezable Pickleback Pops**  
1124060



**Coco Lopez Cream of Coconut**  
1126330



**Ginger Beer 12oz Bottle**  
1550230



**Diet Ginger Beer 12oz Bottle**  
1550232



**Ginger Beer 12oz Can**  
1550250



**MACHINE MIX 1/2 GALLON FLAVORS**



**Strawberry Daiquiri**  
1114120



**Margarita Gold**  
1114000



**Peach Bellini**  
1114124



**Pina Colada**  
1114130



**Red Hurricane**  
1114233



**Bag-In-The-Box Mixes**

- 5 GAL Cola - 1600076
- 5 GAL Lemon/Lime - 1600074
- 3 GAL Cranberry - 1600050
- 3 GAL Tonic - 1600075
- 3 GAL OJ 60% - 1600010
- 3 GAL Sweet & Sour - 1600000
- 3 GAL Energy Drink - 1600085
- 1 GAL Pineapple - 1600060
- 4 LTR - Bloody Mary - 1600065



**Bag-n-Box Connector**  
2141001

**Gelatin Mix**  
24 oz 12 cnt (cs)



**Berry Blue** 1111406  
**Strawberry** 1111405  
**Lime** 1111410  
**Orange** 1111442  
**Watermelon** 1111409  
**Grape** 1111415



**YIELDS**  
840 2oz SHOTS  
PER CASE

**Powdered Crystal Mixes**  
28 oz 12 cnt (cs)



**LEMON SWEET & SOUR** 1111300  
**MARGARITA PERFECTO** 1111306  
**LIME SWEET & SOUR** 1111302

(5+1 YIELD)



**Pimento Stuffed Olives**  
32oz  
1911500



**Pimento Stuffed Olives**  
1 GAL  
1913132



**Stemmed Cherries**  
1/2 GAL  
1910064



**Stemmed Cherries**  
1 GAL  
1910132



**Garlic**  
1902164

**Olive It & More**  
1/2 Gallon  
Gourmet Stuffed  
Queen Olives  
2 cnt/CS



**Jalapeno**  
1902264

**Blaze's Gourmet Spicy Vegetables**  
500 ml  
12 cnt/CS



**Bleu Cheese**  
1902364



**Vodkatini Vermouth**  
1908064



**Lemon**  
1903564



**Green Beans**  
1914800



**Asparagus Spears**  
1914810





**Tabasco Sauce**  
5 oz  
1812006



**Tabasco Sauce**  
12 oz  
1812012



**L & P Sauce**  
5 oz  
1811005



**L & P Sauce**  
15 oz  
1811015



**Angostura Bitters**  
4 oz  
1810004



**Angostura Bitters**  
6.7 oz  
1810010



**Angostura Orange Bitters**  
4 oz  
1810005



**Sugar Packets**  
2,000 cnt  
1820000



**Sweet & Low Packets**  
400 cnt BX  
1820001



**Splenda Packets**  
2,000 cnt  
1820005



**Sugar In-The-Raw**  
1,200 cnt  
1819802



**Stevia In-The-Raw**  
1,000 cnt  
1819800



**Sugar Canisters**  
20 oz  
24 cnt/CS  
1820007

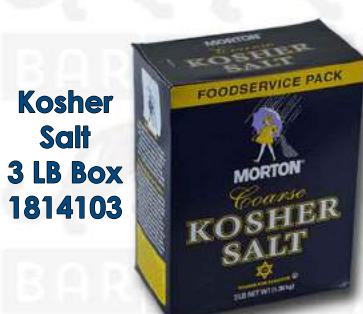

**Kosher Salt**  
3 LB Box  
1814103



**Celery Salt**  
23 oz  
1814016



**Non-Dairy Creamer**  
4.5 oz  
12 cnt/CS  
1111333



**Folgers Coffee Filter Packs**  
8 oz 40 cnt/CS  
1820010



**Western Gold Iced Tea**  
3 oz 32 cnt/CS  
1820023



**Peppermint**  
1881031



**Spearmint**  
1881032



**TRANSLUCENT**



<b>3.5</b>	<b>5</b>	<b>7</b>	<b>9</b>	<b>10</b>	<b>12</b>	<b>14</b>	<b>16</b>
2,500 cnt 900004D	2,500 cnt 900005G	2,500 cnt 900007G	2,500 cnt 900009D	2,500 cnt 900010D	1,000 cnt 900012D	1,000 cnt 900014D	1,000 cnt 900016D

**P.E.T.**



<b>9</b>	<b>12</b>	<b>16</b>	<b>10</b>	<b>16</b>
1,000 cnt 9000089	1,000 cnt 9000091	1,000 cnt 9000093	500 cnt 9000210	500 cnt 9000216

**HARD PLASTIC**

**FOAM**



<b>6</b>	<b>8</b>	<b>12</b>	<b>16</b>	<b>20</b>	<b>24</b>	<b>32</b>
1,000 cnt 9000106	1,000 cnt 9000108	1,000 cnt 9000113	1,000 cnt 9000116	500 cnt 9000120	500 cnt 9000124	500 cnt 9000132



1,000 cnt  
9003016



500 cnt  
9003032

**Paper Cone**  
4 oz Cups  
5,000 cnt  
6164104



400 cnt  
9013302



1,008 cnt  
9000516

**16 DISPOSABLES**





**PORCION CUPS & LIDS**  
2,500 cnt each SKU



**SHOOTERS & BOMBERS**



**TUBE SHOTS**



**HARD PLASTIC**





**5.5**

72 cnt  
9219955



**7**

72 cnt  
9219907



**9**

72 cnt  
9219909



**10**

72 cnt  
9219910



**12**

72 cnt  
9219912



**14**

72 cnt  
9219914



**16**

72 cnt  
9219916



CLEAR PINT

**16**

24 cnt  
9210235



TEXTURED

**20**

72 cnt  
9216620



TEXTURED

**32**

48 cnt  
9216632R



TEXTURED

**32**

48 cnt  
9216632B



**6**

24 cnt  
9210240



**8**

24 cnt  
9210243



**15**

24 cnt  
9210250



**6**

24 cnt  
9210255



3 cnt  
9210258

**48**





**12**  
24 cnt  
9210212



**16**  
24 cnt  
9210216



**20**  
12 cnt  
9210274



**22**  
24 cnt  
9210232



**32**  
12 cnt  
9210032



**60**  
12 cnt  
9210060



**60**  
12 cnt  
9210160



**8.4**  
12 cnt  
9211025



**17**  
12 cnt  
9211050



**1LTR**  
12 cnt  
9211100



**1 oz SHOT**  
24 cnt  
9210279



**1.5 oz LINED SHOT**  
24 cnt  
9210280



4.5  
36 cnt  
9915248



5.5  
36 cnt  
9915249



7  
36 cnt  
9915241



8  
36 cnt  
9915240



9  
36 cnt  
9915242



9  
36 cnt  
9915231



9  
36 cnt  
9915236



10  
36 cnt  
9915232



10  
36 cnt  
9915237



12  
36 cnt  
9915243



12  
36 cnt  
9915238



14  
36 cnt  
9915244



16  
24 cnt  
9915256



22  
24 cnt  
9915253



3.75  
12 cnt  
9915733



5  
12 cnt  
9915842



7  
12 cnt  
9915709



9  
12 cnt  
9915710



12  
12 cnt  
9915712



10  
12 cnt  
9915711



12  
12 cnt  
9915713



14  
12 cnt  
9915714



3  
36 cnt  
9902303



10.5  
36 cnt  
9902338



12.5  
36 cnt  
9902339



12  
72 cnt  
9900096



10.25  
36 cnt  
9923386



10.5  
36 cnt  
9923106



8.5  
36 cnt  
9915246



11.5  
36 cnt  
9915247



5.5  
24 cnt  
9903746



8  
24 cnt  
9903736



10  
24 cnt  
9903737





36 cnt  
9903766



24 cnt  
9903765



24 cnt  
9903764



24 cnt  
9908464



36 cnt  
9903964



24 cnt  
9903965



24 cnt  
9903057



12 cnt  
9907516



12 cnt  
9907515



12 cnt  
9907502



12 cnt  
9907510



12 cnt  
9907505



12 cnt  
9907504



12 cnt  
9903795



12 cnt  
9907500



12 cnt  
9907511



12 cnt  
9900217



12 cnt  
9900221



12 cnt  
9900400



36 cnt  
9908455



12 cnt  
9907700



12 cnt  
9907512



12 cnt  
9908480



12 cnt  
9907518



12 cnt  
9907507



**23**

12 cnt  
9901623



**23**

12 cnt  
9901610



**12**

12 cnt  
9905212



**18**

12 cnt  
9700824



**14**

24 cnt  
9915141



**16**

24 cnt  
9901639



**22**

24 cnt  
9915722



**10**

12 cnt  
9905019



**12**

12 cnt  
9905016



**14**

12 cnt  
9905018



**16**

12 cnt  
9905020



**10**

12 cnt  
9905205



**12**

12 cnt  
9905206



**8.5**

24 cnt  
9905307



**10**

12 cnt  
9905362



**12**

24 cnt  
9905309



**12.5**

12 cnt  
9952733



**15**

12 cnt  
9905011



**16.5**

12 cnt  
9997084



**22**

12 cnt  
9905001



**22**

12 cnt  
9905360



**25**

12 cnt  
9905272



**1 LTR**

12 cnt  
9905262



**8.5**

24 cnt  
9905295





20

Singles  
2409620



10

12 cnt  
9903817



13

12 cnt  
9903807



5.5

12 cnt  
9903702



9

24 cnt  
9903704



12

24 cnt  
9903705



22

12 cnt  
9903709



13.25

12 cnt  
9903717



15

12 cnt  
9903617



15

12 cnt  
9903616



23.5

12 cnt  
9903623

6 cnt  
9905260



60

REGULAR BASE

1.5



12/72 cnt  
9905120

1.5/1



12/72 cnt  
9905120A

1.25



12/72 cnt  
9905121

1



12/72 cnt  
9905122

1



12/72 cnt  
9905031

HEAVY BASE

2



12/48 cnt  
9905126

2/1



12/48 cnt  
9905126A

1.5



12/48 cnt  
9905127

1.25



12/48 cnt  
9905135

1



12/48 cnt  
9905138



4

48 cnt  
9905131



**Deli Cups  
Clear  
(500 cnt)**



**32**  
9000390

**16**  
9000386

**8**  
9000378

**12**  
9000382

LIDS - 9000395

**Laminated Foil Wrap Sheets**



**12"x12"**  
2,500 cnt  
9103530



**14"x16"**  
1,000 cnt  
9103532

**Wax Sandwich Wrap  
14"x14"**  
4,000 cnt  
6115141



**Wax Patty Paper  
5.5"x5.5"**  
24,000 cnt  
6115455



**Dry Wrap  
12"x12"**  
2,000 cnt  
6115112



**Aluminum Steam Pans & Lids  
(500 cnt)**



**10 3/8"x12 3/4"**

**12 13/16"x20 3/4"**

**Half Lids  
9002812**

**Half Pans  
9002802**

**Full Lids  
9002810**

**Full Pans  
9002800**

**Full Sheet Pan Liners  
16"x24"**  
1,000 cnt  
6115460



**Foil Wrap Cutterbox  
18"x500'**



9102618

**Food Rotation  
Labels  
2" x 3"**  
250 cnt  
6168023



**Use First  
Labels  
2" Round**  
500 cnt  
6168030



**Peach  
Treated  
Butcher  
Paper  
Roll**

**18"x1000'**  
6160318



**Film Wrap Cutterbox  
18"x2000'**



9100218







9.25" x 9.25" x 3"  
(200 cnt)

9002633K

3-Comp

1-Comp

9002631K



9.5" x 9.25" x 3"  
(200 cnt)

9002333

3-Comp

1-Comp

9002303



8.25" x 8.25" x 3"  
(250 cnt)

9002715  
1-Comp Clear



9" x 9" x 3"  
(250 cnt)

9002759  
Sugar Cane 1-Comp White



6" x 6" x 3"  
(500 cnt)

9002306  
Hamburger White



6" x 6" x 3"  
(500 cnt)

9002601K  
Hamburger Black



Paper Food Trays  
(500 cnt)

6150500

5LB

6150300

3LB

2LB

6150200



Vented Lid  
(1,000 cnt)  
9003262

Foam Squat  
(1,000 cnt)  
9002256

Foam Squat  
(1,000 cnt)  
9002258



10.25"  
(500cnt)

6155049



Moist  
Towelettes  
(1,000 cnt)  
6112520

Medium Weight White  
(1,000 cnt)



9004105

9004102

9004103

9004101

Picnic Cutlery Packs  
(250 cnt)



Medium Weight  
9004300

Heavy Weight  
9004325

Thank You Bags  
(1,000 cnt)  
9105002



11" x 7" x 22"



2 lb  
500 cnt  
6170040



4 lb  
500 cnt  
6170050



6 lb  
500 cnt  
6170056



8 lb  
500 cnt  
6170065



10 lb  
Bulwark  
500 cnt  
6170073



12 lb  
Bulwark  
500 cnt  
6170084



25 lb  
Shorty  
Bulwark  
500 cnt  
6170030



1/6 th Grocery  
SuperTuff  
400 cnt  
6170125



250 cnt  
6180062

10"x6 3/4"x12"



200 cnt  
6180072

14"x10"x15 3/4"





**3.13" x 220'**  
(50 cnt)  
1-PLY THERMAL

**6023203**  
(54-220)



**3" x 220'**  
(50 cnt)  
1-PLY THERMAL

**6023324**  
(46-015)



**3" x 190'**  
(50 cnt)  
1-PLY BOND

**6023503**  
(11-105)



**2.25" x 165'**  
(50 cnt)  
1-PLY THERMAL

**6023200**  
(15-165)



**2.25" x 85'**  
(50 cnt)  
1-PLY THERMAL

**6023201**  
(15-185)



**2.25" x 50'**  
(50 cnt)  
1-PLY THERMAL

**6023199**  
(15-350)



**3" x 95'**  
(50 cnt)  
2-PLY BOND

**6023523**  
(18-235)

**CHECK YOUR TAPE'S  
DIAMETER & WIDTH**

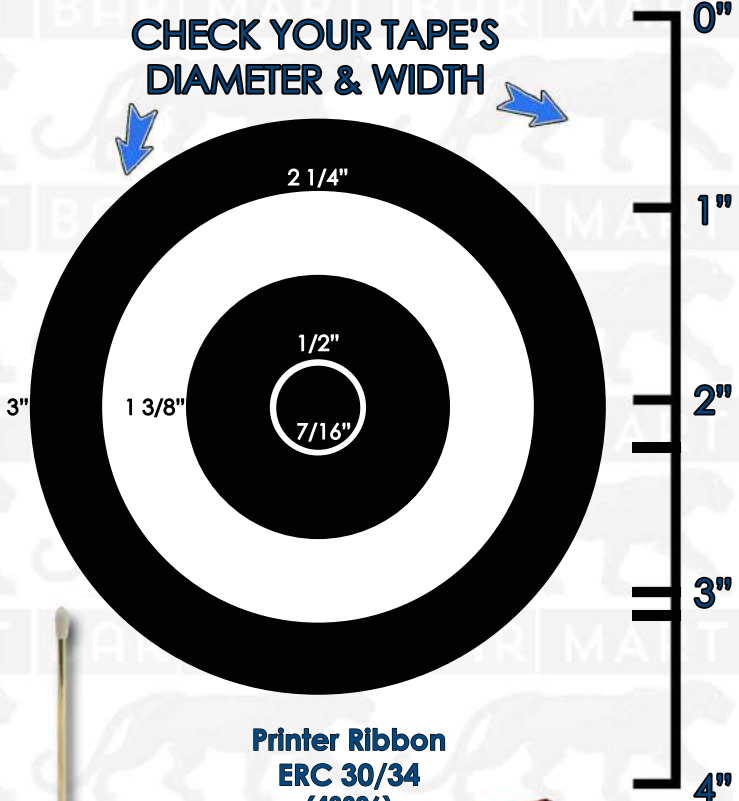

**Guest Checks 3.5" x 6.75"**  
50/50 cnt



**With Receipt**  
**6003632**



**w/o Receipt**  
**6003674**

**Check  
Spindle**  
**2408113**



**Printer Ribbon**  
**ERC 30/34**  
(43306)



**6023034**



8900504  
(10/1,000 cnt)  
SIP STIX

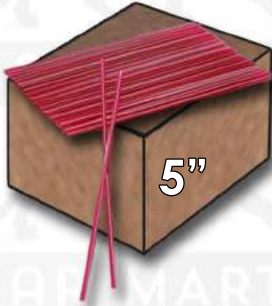

5"

8900512  
(10/1,000 cnt)  
SIP STIX



5"

8900700  
(50/250 cnt)  
JUMBO

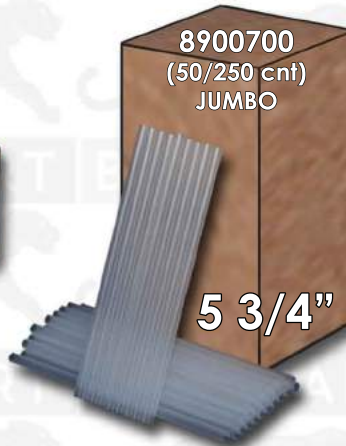

5 3/4"

8900701  
(50/250 cnt)  
JUMBO



5 3/4"

8900800  
(50/250 cnt)  
JUMBO



7 3/4"

8900810  
(50/250 cnt)  
JUMBO



7 3/4"

8900600  
(10/500 cnt)  
SLIM

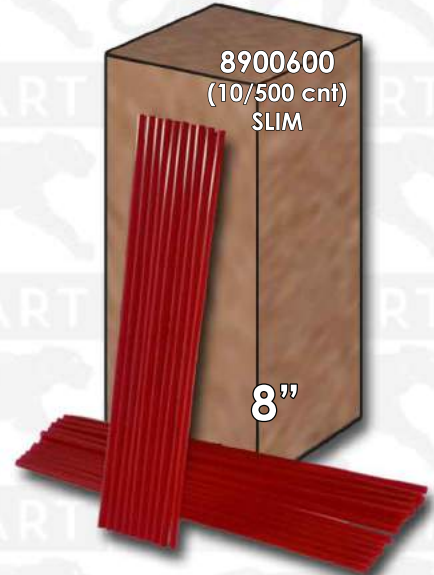

8"

8900901  
(2,000 cnt)  
JUMBO



10.25"

3.5" Triangle Crystal Picks  
2,500 cnt



8902200



8902201

Parasols  
144 cnt  
8903000



Wrapped Toothpicks  
12,000 cnt  
6114044



Sword Picks  
1,000 cnt  
8901000



4" Bamboo Picks  
Olive Green  
1,000 cnt  
8902224





**ALL COLORS ARE  
500 COUNT BOXES**

**8801155**



**8801152**



**8801111**





White Roll Towel



8"x800'  
(6 cnt)

6112314

Brown Roll Towel

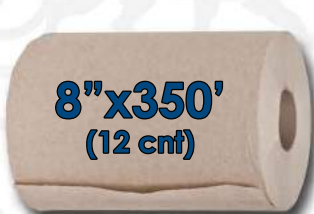

8"x350'  
(12 cnt)

6112302

Brown Roll Towel

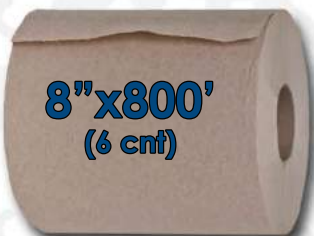

8"x800'  
(6 cnt)

6112303

Center Pull Towel



8"  
(6 cnt)

6112100

Perforated Roll Towel



11"  
(30 cnt)

6112400

Multi-Fold Towel



6112001  
(4,000 cnt)

Multi-Fold Towel



6112002  
(4,000 cnt)



15"x17"  
1/8-FOLD  
(3,000 cnt)

6113222

Dinner  
Napkins



17"x17"  
1/4-FOLD  
(4,000 cnt)

6113201

Paper Napkin Rings



6114010  
(20,000 cnt)

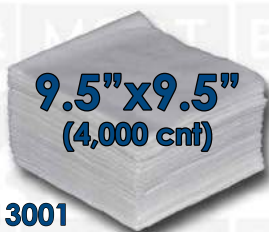

9.5"x9.5"  
(4,000 cnt)

6113001

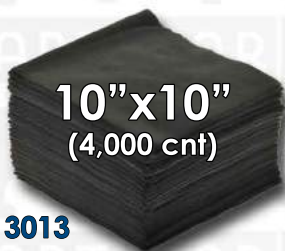

10"x10"  
(4,000 cnt)

6113013



10"x10"  
(4,000 cnt)

6113000

STANDARD  
HOUSEHOLD  
ROLLS  
96-COUNT



6111002

9" JUMBO ROLLS  
2-PLY  
12-COUNT



6111102



# ASK YOUR SALES REP ABOUT OUR DISPENSER PROGRAMS & OPTIONS



**CENTER-PULL  
PAPER TOWEL**  
6140025



**TOUCHLESS  
PAPER TOWEL**  
6140100



**DOUBLE 9"  
TOILET PAPER**  
6140120



**LEVER-ACTION  
ROLL PAPER TOWEL**  
6140081



**KUTOL  
SOAP  
&  
SANITIZER**

6711400



6711401



55 GAL  
38"x58"  
2 MIL  
50 cnt



Rolled  
6203659

55 GAL  
38"x58"  
1.2 MIL  
100 cnt



Rolled  
6203658

40-45 GAL  
40"x46"  
1.2 MIL  
100 cnt



Rolled  
6204049

23 GAL  
28"x38"  
1.0 MIL  
150 cnt



Rolled  
6202838

40-45 GAL  
40"x48"  
14 MIC  
250 cnt



Rolled  
6204048

15 GAL  
24"x33"  
0.5 MIL  
500 cnt



Rolled  
6202433

55 GAL  
38"x58"  
0.74 MIL  
100 cnt



Flat-Pack  
6203858



32 GAL  
6213200

44 GAL  
6214444

55 GAL  
6215500



23 GAL  
6217025

23 GAL  
6217023

23 GAL  
6217024



DOLLY FOR  
32, 44 & 55 GAL  
CONTAINERS  
6213255



DOLLY FOR  
RECTANGULAR  
CONTAINERS  
6213551



28  
QT

OFFICE TRASH  
CONTAINER  
6212956



17  
GAL

STAINLESS STEEL  
SWIVEL-TOP  
CONTAINER  
6219000

BUS TUBS 21"x17"x7"



6223351B

6223351



ANTI-FATIGUE MAT  
3'X5'

2202000





**POWDER-FREE LATEX GLOVES**  
1,000 cnt/CS  
(100 cnt/BX)



6309997 6309999 6310000 6309998

**BLUE NITRILE**



L  
100 cnt/BX

6310012



**ACRYLIC  
GLOVE HOLDER**  
HOLDS 3 BOXES

6311003

**KUTOL FOAMING  
REFILLS**  
6/1,000 ml



**SOAP**  
6711450

**SANITIZER**  
6711490

**GOJO SOAP  
REFILLS**



**TOUCHLESS**  
2/1,200 ml  
6711370



**LOTION SOAP**  
12/800 ml  
6710936



**MANUAL**  
3/1,250 ml  
6711350



**BEER CLEAN  
GLASS SOAP**  
2/4 lb  
6590201



**BEER CLEAN  
GLASS SOAP**  
100/0.5 oz  
6590221



**BEER CLEAN  
LOW SUDS**  
100/0.5 oz  
6590224



**BEER CLEAN  
LAST RINSE**  
100/0.25 oz  
6590223



**STERAMINE  
SANITIZING TABS**  
6/150 cnt  
6733330



**BOARDWALK  
LOTION SOAP**  
12/8 oz  
6711107

**OVERFLOW  
TUBES**



**MEDIUM**  
1" X 1 3/8"  
6333287

**LARGE**  
1 1/4" X 1 3/4"  
6333300



**TRIPLE BRUSH**  
6340095



**QUAT TEST STRIPS**  
15-PACK  
6340100



4/1 GAL  
**CRUD BUSTER**  
6601311



4/1 GAL  
**VALUE LINE DEGREASER**  
6601341



4/1 GAL  
**OVEN LOVEN**  
6609201



4/1 GAL  
**ZYME-A-LIVE**  
6606301



4/1 GAL  
**LIME BUSTER**  
6603341



4/1 GAL  
**FABULOSO LAVENDER**  
6713660



6/1 GAL  
**SIMPLE GREEN CLEANER**  
6713628



4/1 GAL  
**GLASS CLEANER RTU**  
6601101



6/32oz  
**GLASS CLEANER RTU**  
6601102



9/32oz  
**FORMULA 409 GLASS & SURFACE**  
6713670



4/1 GAL  
**SOFT PURITY**  
6602011



4/1 GAL  
**ROSE PINK**  
6602000



4/1 GAL  
**BAR-TEND-R**  
6602301



8/38oz  
**DAWN**  
6710930



4/1 GAL  
**RUBBING ALCOHOL 70% ISOPROPYL**  
6711565





4/1 GAL

**BAR MART PINE**  
6601211



4/1 GAL

**BAR MART LEMON**  
6601201



3/144 OZ

**PINE-SOL**  
6713621



6/1 GAL

**BLEACH**  
6712306



4/1 GAL

**BALANCE**  
6601001



4/1 GAL

**NOO-SLIP**  
CLEANER  
6605501

12/25oz



**SCRUBBING**  
BUBBLES  
6590962

9/32oz



**TILEX**  
MILDEW  
6714032

90/0.5oz  
Packs  
(2cnt)



**EASY PAKS**  
CLEANER  
6590652

12/9.7oz



**PLEDGE**  
POLISH  
6594430



6/32oz

**STAINLESS**  
STEEL POLISH  
6601152



32oz

**SPRAY**  
BOTTLE  
9200332

6/12oz



**SUPER-SORB**  
SPILL  
ABSORBANT  
6711550

12/6oz



**BOARDWALK**  
GUM  
REMOVER  
6713602



**FIRST AID KIT**  
FOR 25  
6222020

**BAR PRO**  
FRUIT FLY STRIPS  
10 cnt/CS  
6760412



**TRIPLE CROWN**  
DANCE WAX



**1LB**  
6711601

**24LB**  
6711603



WIRE FRAME 6230015



5" x 24"

DUST MOP SET-UPS

WIRE FRAME 6230017



5" x 36"



MOP HEAD 6230014



MOP HEAD 6230016



HANDLE 60" 6230010

WAREHOUSE BROOM 100% CORN 6230004



ANGLE BROOM POLYPROPYLENE 6230008



PUSH BROOM HEAD 24" 6230006



PUSH BROOM HANDLE 60" 6230007



SCRUBBERS

LOBBY DUST PAN 6232531



TOY BROOM 6230002



SPONGE WITH GREEN NYLON 20 cnt/CS 6230110



STAINLESS STEEL 1.75 oz 12cnt/BX 6230111



GREEN NYLON SCRUBBER 20 cnt/CS 6230108



GRILL BRICKS 3 1/2"x4"x8" 12cnt/CS 6231018





**HANDLE 60"  
6240460**



**24-OUNCE**

**6250124**



**32-OUNCE**

**6250132**



**HEAVY-DUTY  
BLUE YARN  
MOP  
6250232**

**RUBBER 18"  
6230038**



**RUBBER 24"  
6230040**



**FOAM 22"  
6230045**



**FOAM 30"  
6230047**



**HANDLE 60" 6230043**

**YELLOW MOP BUCKET  
WITH WRINGER  
36 QT  
6266950**



**WET  
FLOOR  
SIGN  
6266112**



**SPLASH HOG URINAL MATS**



**TANGO MANGO**  
6303008



**CUCUMBER MELON**  
6303009



**ANTI-MICROBIAL URINAL MAT**  
20"x25"  
6300120

**ULTRA-AIR URINAL SCREENS**

10 cnt/CS

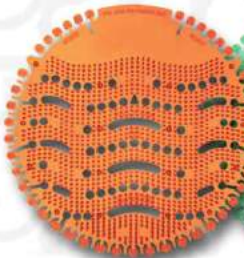

**TANGO MANGO**  
6302008

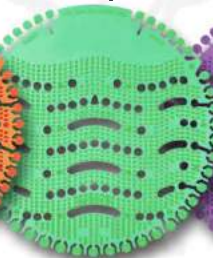

**CUCUMBER MELON**  
6302009



**PURPLE CRUSH**  
6302010

**URINAL SCREENS**

6300020



**URINAL BLOCK**  
6300022



**URINAL SCREEN W/BLOCK**  
6300010

**ULTRA-AIR ROOM REFRESHERS**

6 cnt/CS



**TANGO MANGO**  
6302508



**CUCUMBER MELON**  
6302509



**PURPLE CRUSH**  
6302510



**AIR-FRESH CABINETS**  
6302500

**TIMED AIR FRESHENERS**

CITRUS 7oz  
6710806



**TIMED AIR FRESHENER DISPENSER**

6710800

**SANITARY NAPKIN DISPOSAL BIN**

WHITE FLOOR MODEL

6222000



**WAXED LINERS**

9"x10"x3"  
250cnt  
6206145



**FEBREZE SPRING REFRESHENER**

6/8.8oz  
6720000

**NOW OFFERING BAR FURNITURE**



**24" 3320024**  
**30" 3320030**

**24" 3320124**  
**30" 3320130**

**24" 3320224**  
**30" 3320230**

**24" 3320324**  
**30" 3320330**

**24" 3320424**  
**30" 3320430**

**24" 3320524**  
**30" 3320530**



**24" 3325024**  
**30" 3325030**

**24" 3325124**  
**30" 3325130**

**24" 3325224**  
**30" 3325230**

**24" 3325324**  
**30" 3325330**

**24" 3325424**  
**30" 3325430**

**24" 3325524**  
**30" 3325530**



**17.75" 3310000**

**17" 3310010**

**17.5" 3310012**

**30" 3331003**

**30" 3331103**

**31.5" 3331012**

**WE NOW OFFER OVER 1,000 DIFFERENT STYLES OF BAR SEATING, TABLES & OTHER FURNITURE. CONTACT YOUR SALES REP FOR MORE DETAILS.**

# DALLAS - FORT WORTH



Bar Mart has been servicing the hospitality industry in North Texas since 1953, primarily focusing on bars, restaurants and night clubs.

Over the past few decades, Bar Mart has achieved considerable sales growth by not only expanding our product offerings, but by also continuing to personalize services offered to our valued customers.

We look forward to building more relationships in the Texas hospitality industry for decades to come.



## AUSTIN SAN ANTONIO

In August of 2017, Bar Mart began servicing Austin and San Antonio, and in January 2018, we moved into our current Central Texas location in Manor, TX.



Pricing within is to be considered confidential & subject to change without notice. Product availability is also subject to change without notice.

BM#CL18